

TOMI

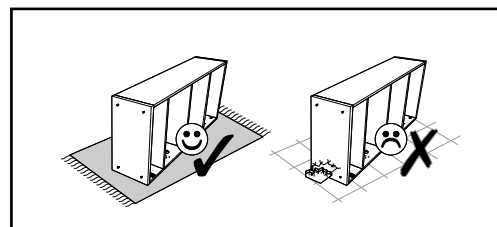

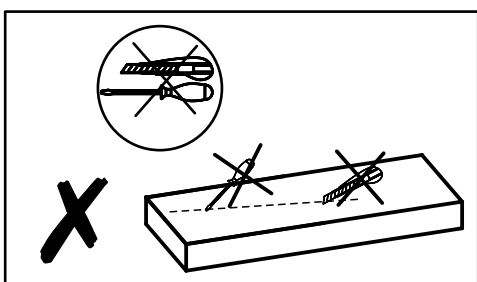

①A	895x650	1	1/2
①B	895x650	1	1/2
②	1800x118	1	2/2
③	1800x118	2	2/2
④	1000x100	1	2/2
⑤	315x80	1	1/2
⑥	315x80	1	1/2
⑦	1780x150	1	2/2
⑧	600x110	1	1/2
⑨	600x110	1	1/2
⑩	582x110	1	1/2
⑪	1695x110	1	2/2
⑫	863x608	2	1/2

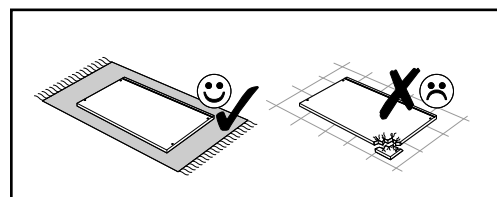
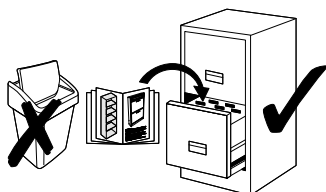
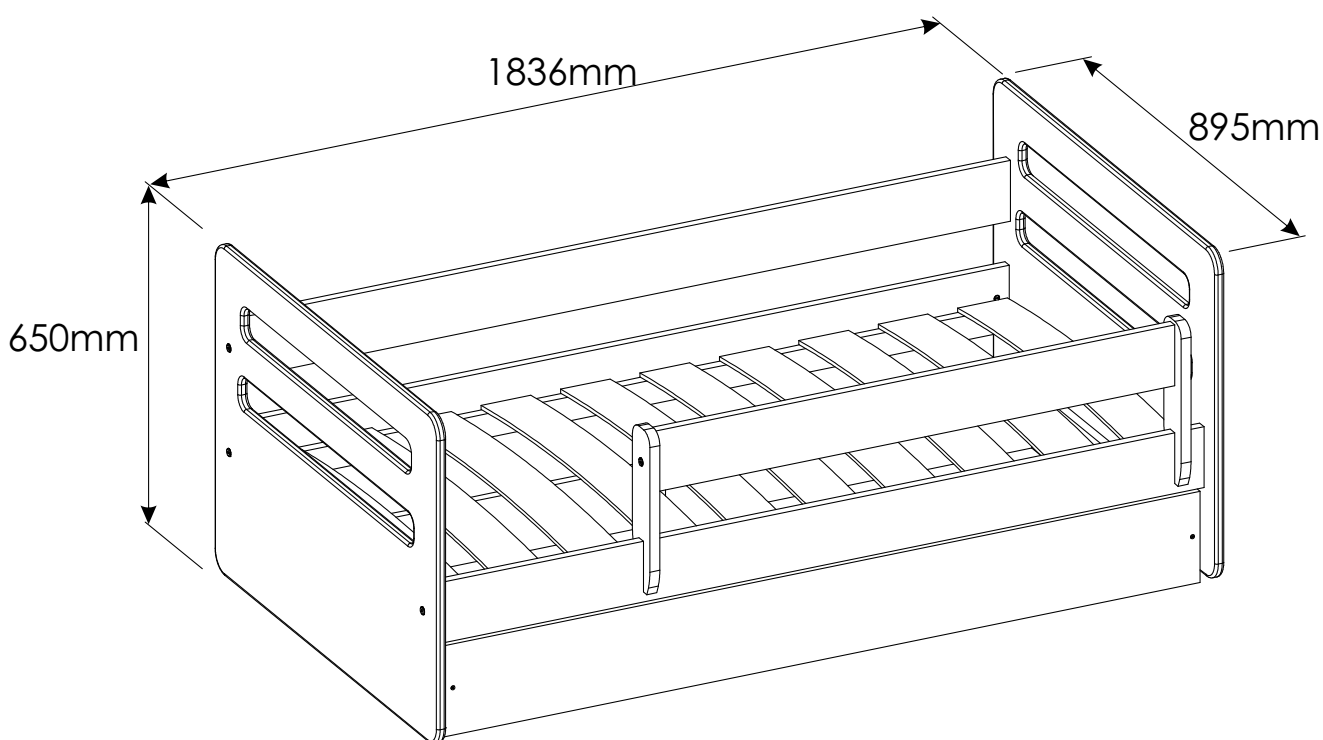
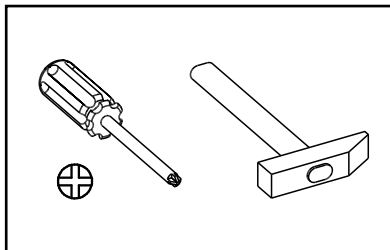
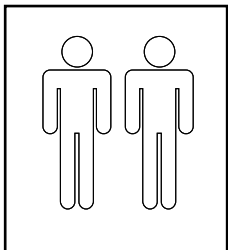
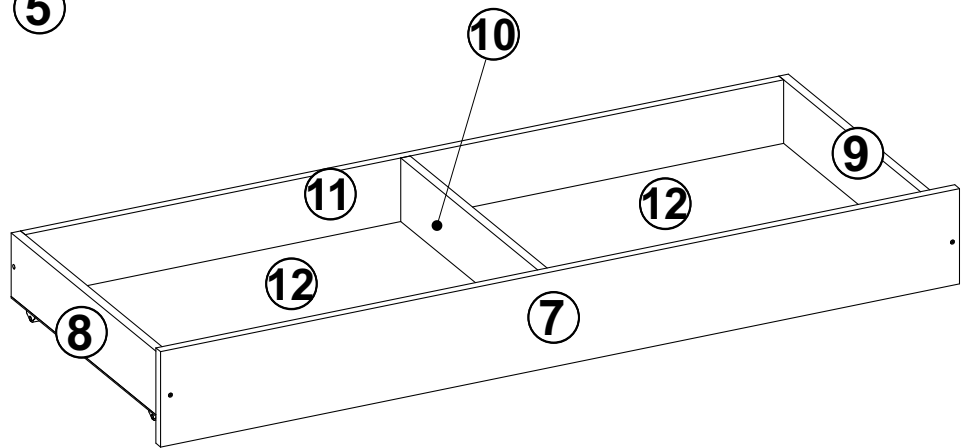
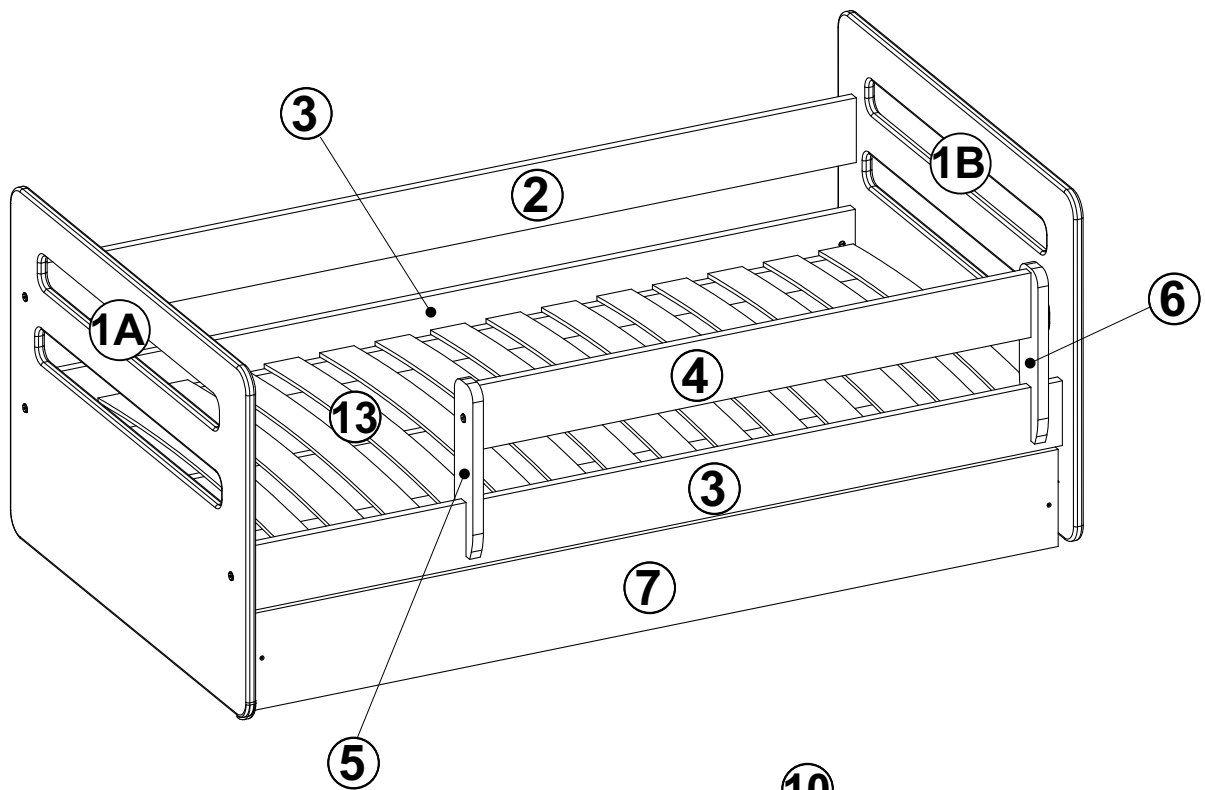
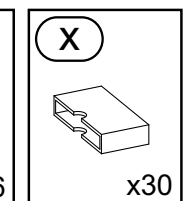
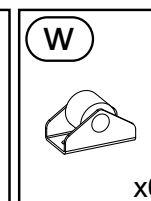
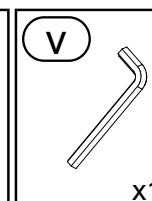
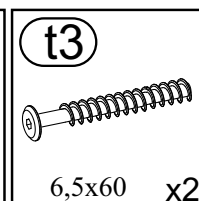
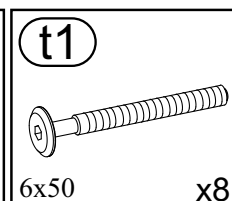
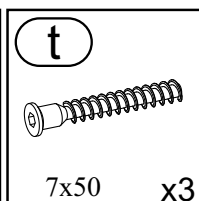
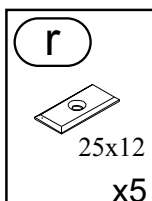
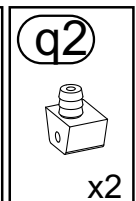
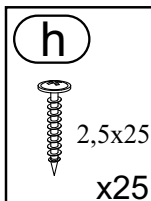
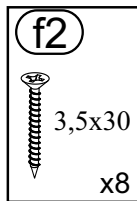
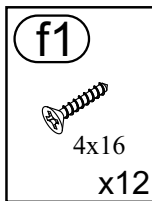
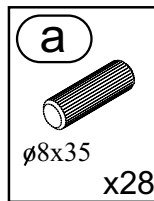

1

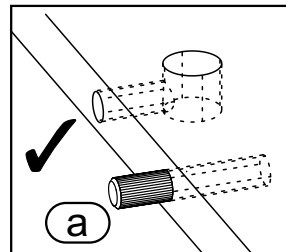
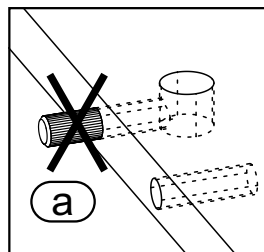
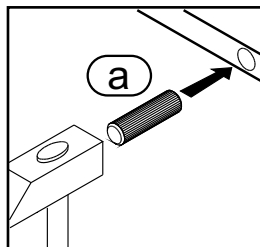
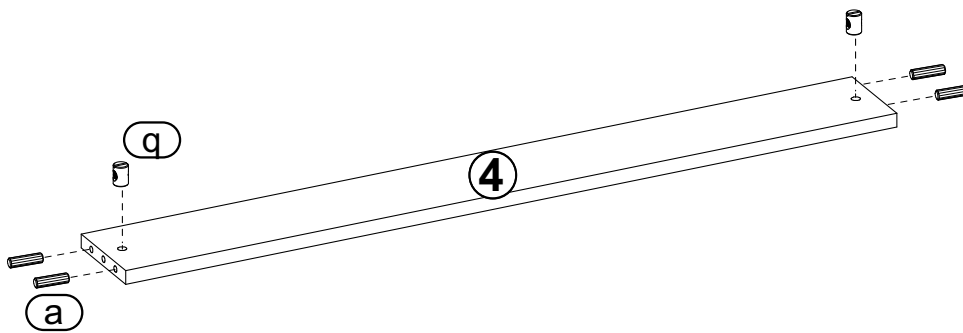
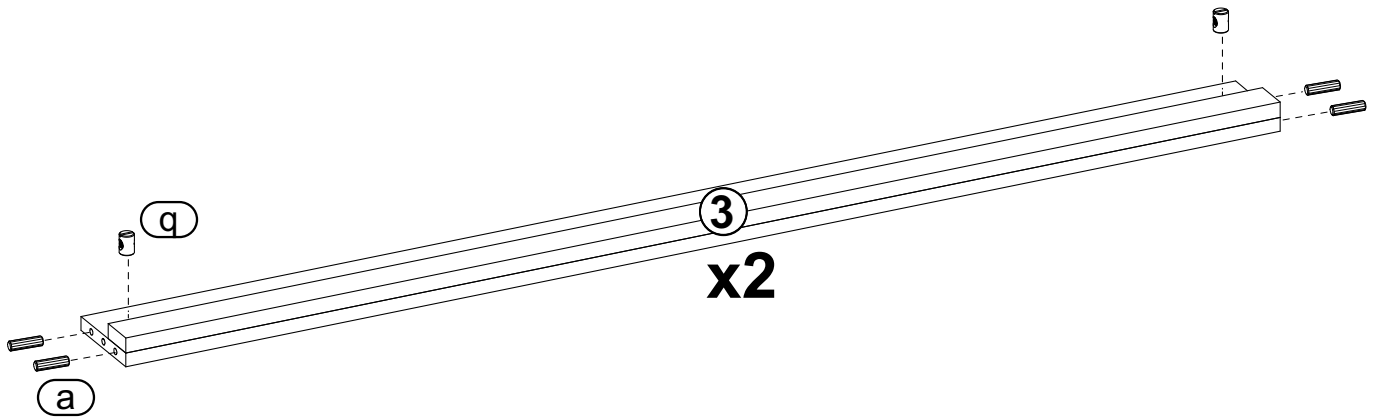
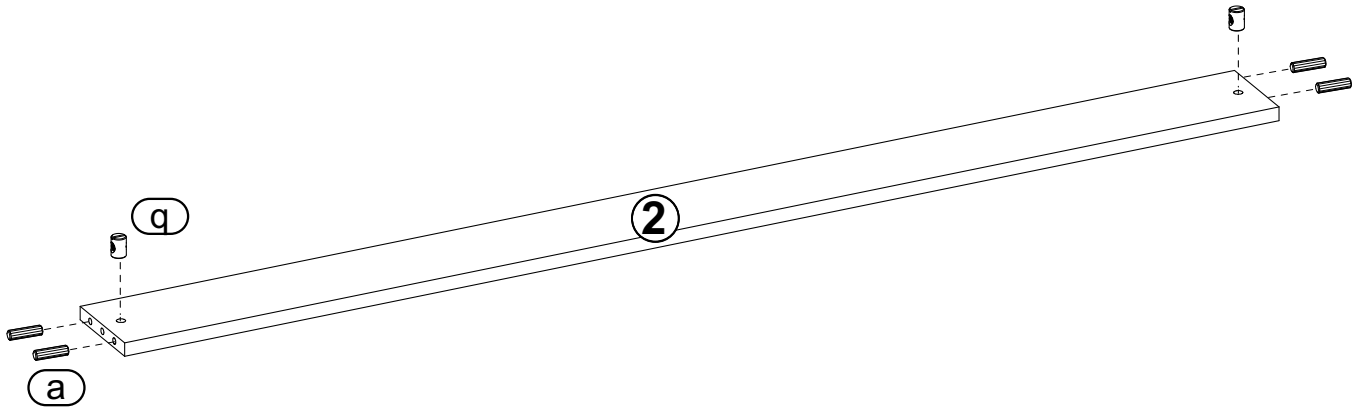
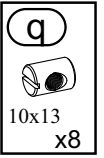
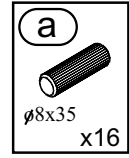
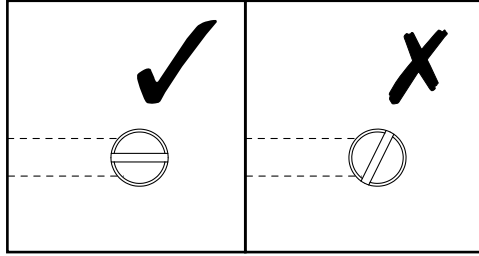
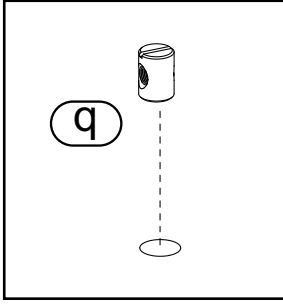

2

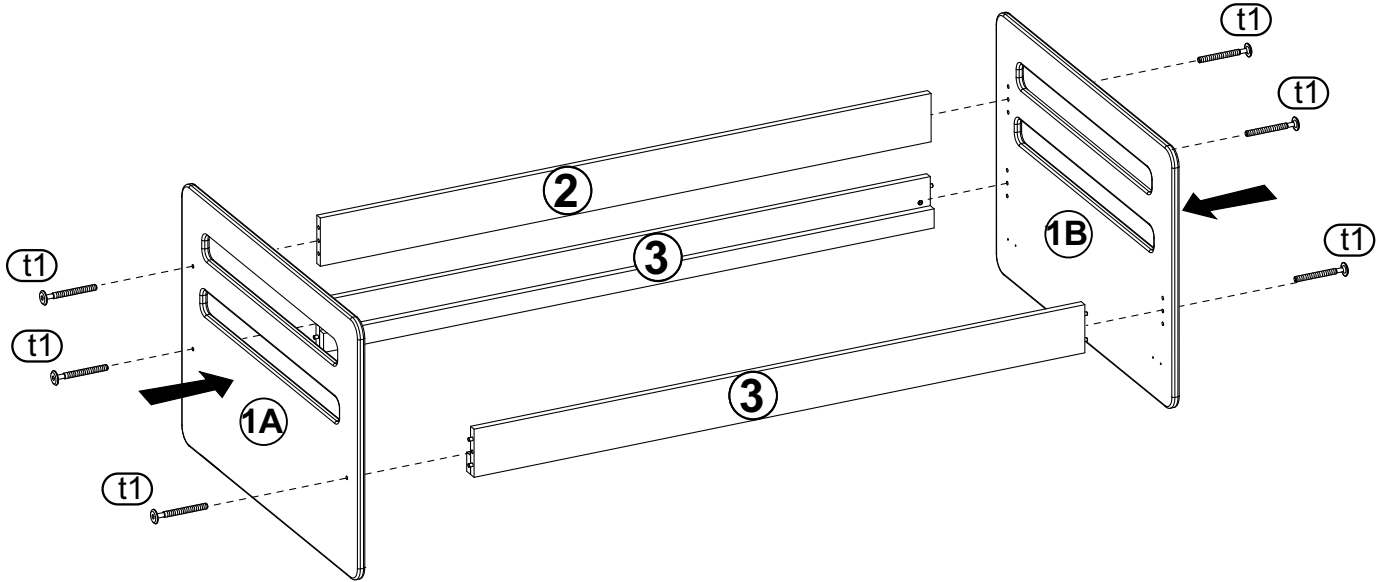
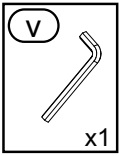
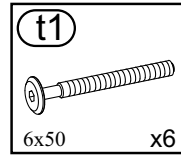
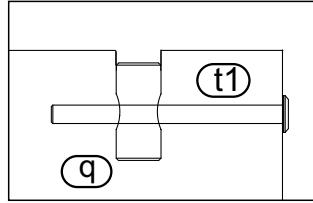
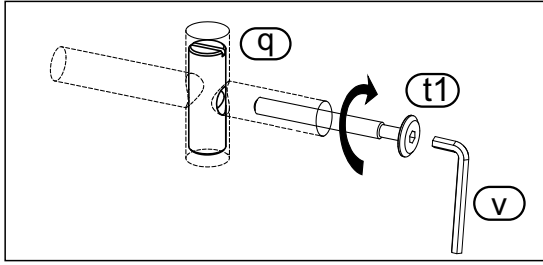

3

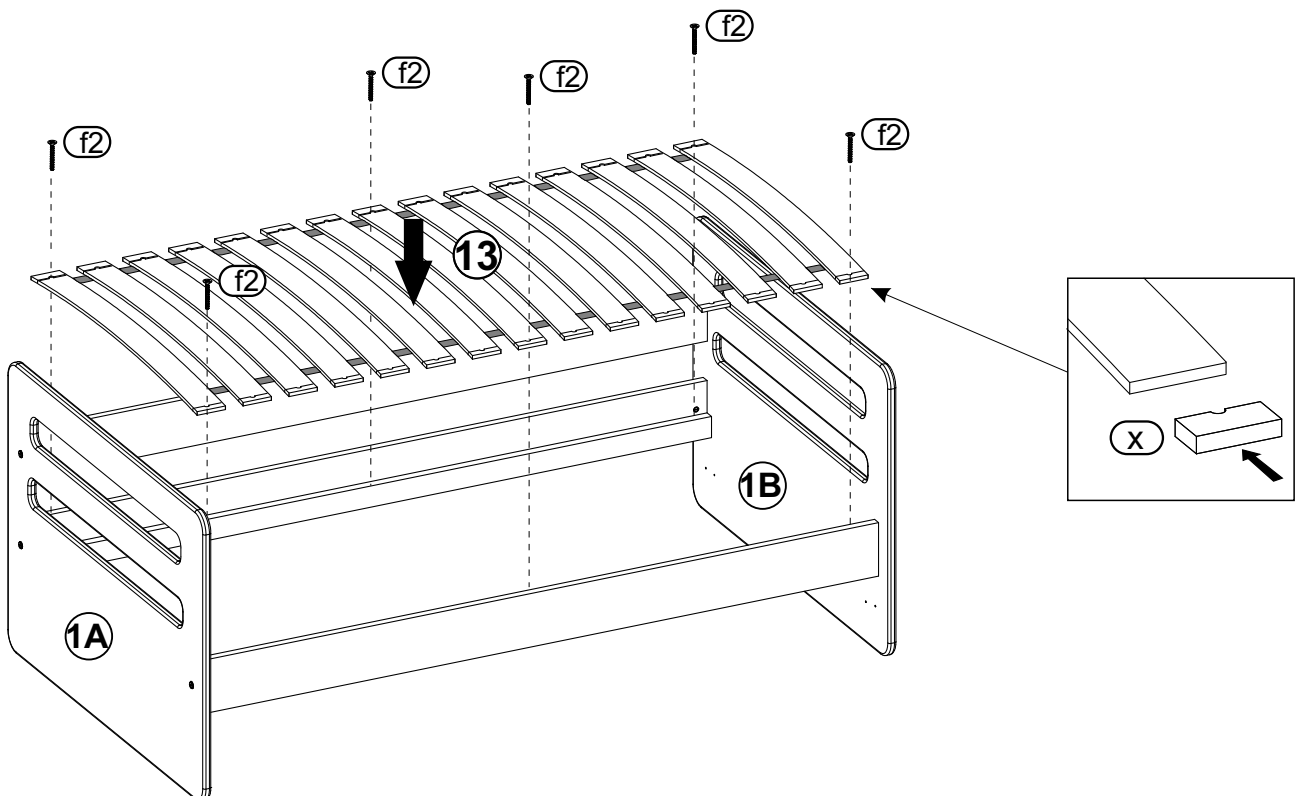
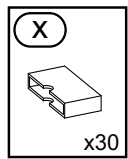
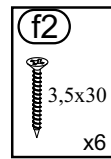
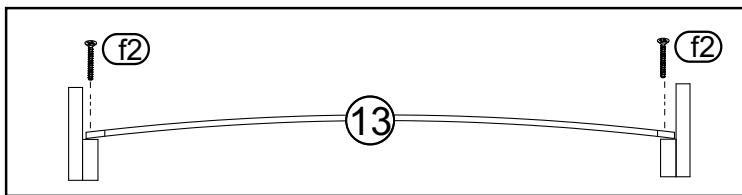

4

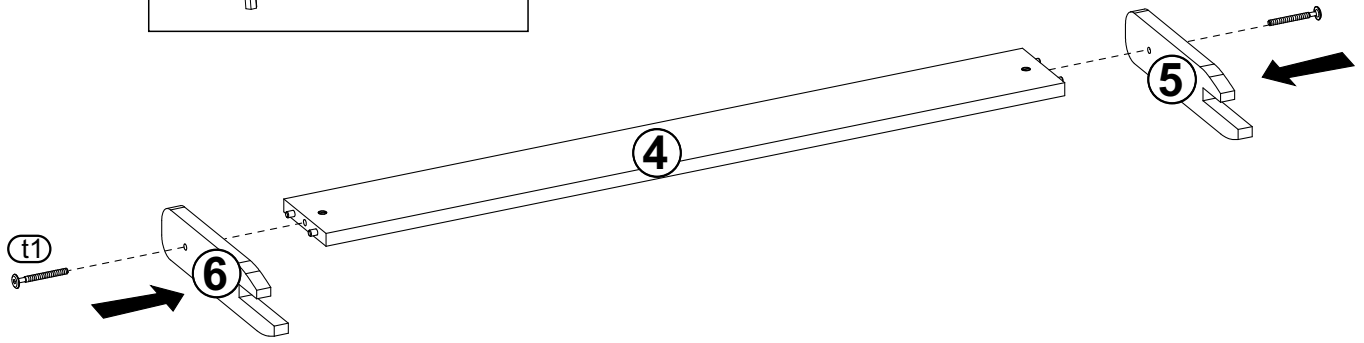
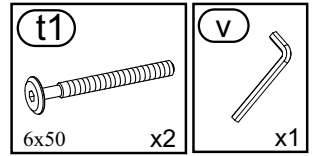
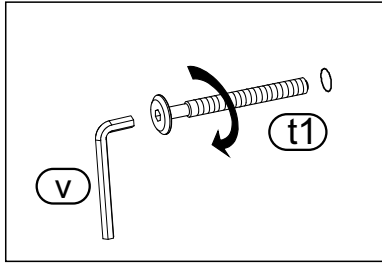

5

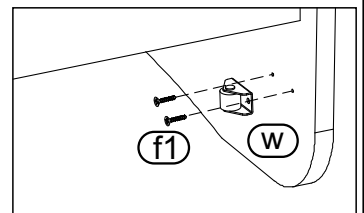
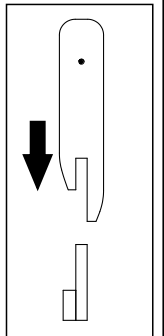
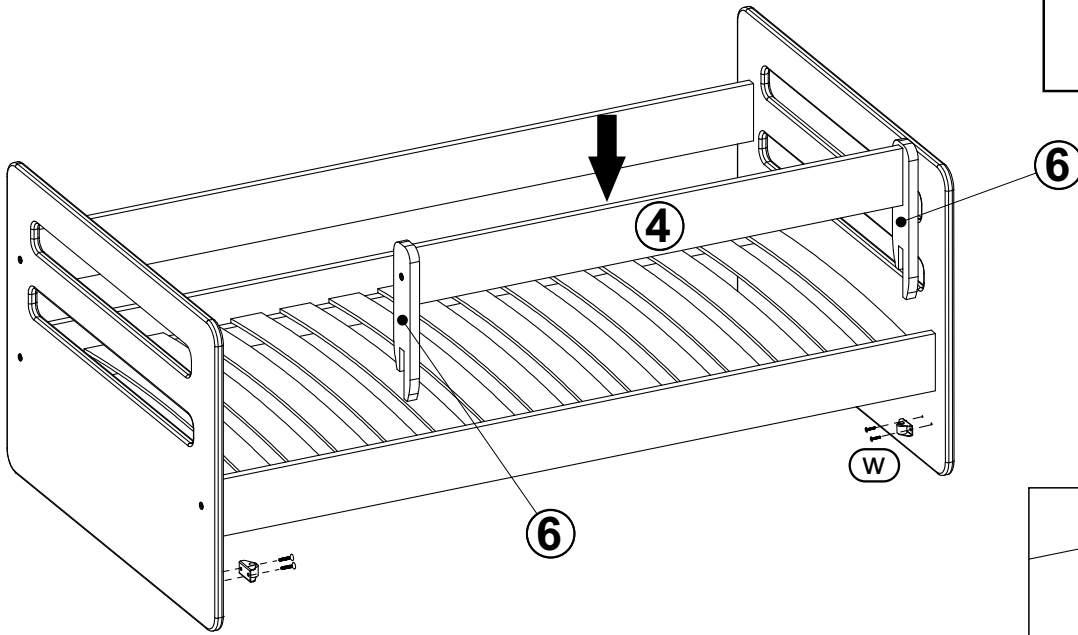
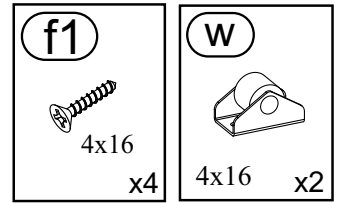

6

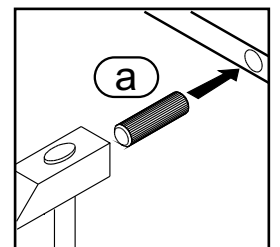
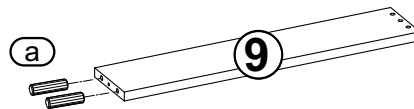
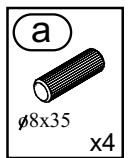
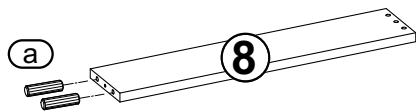

7

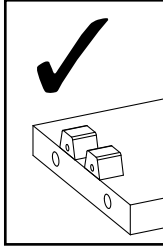
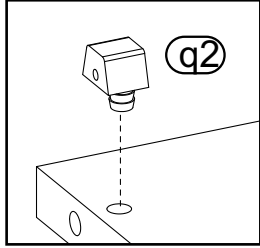
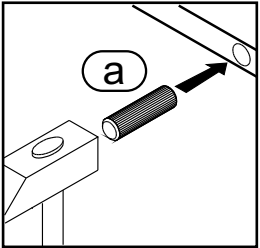
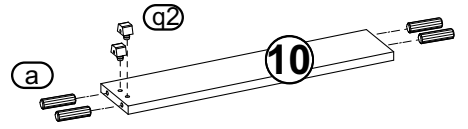
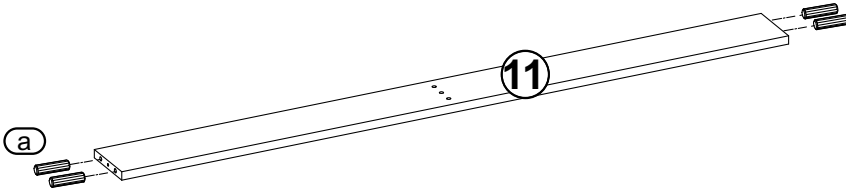
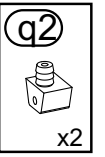
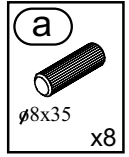

8

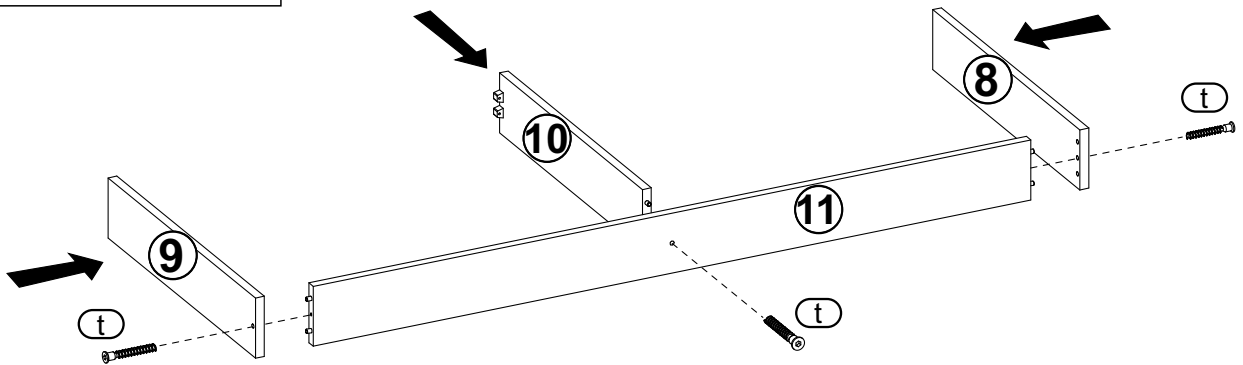
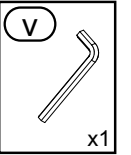
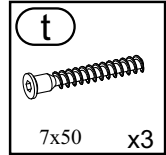
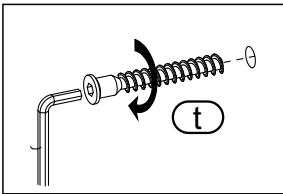

9

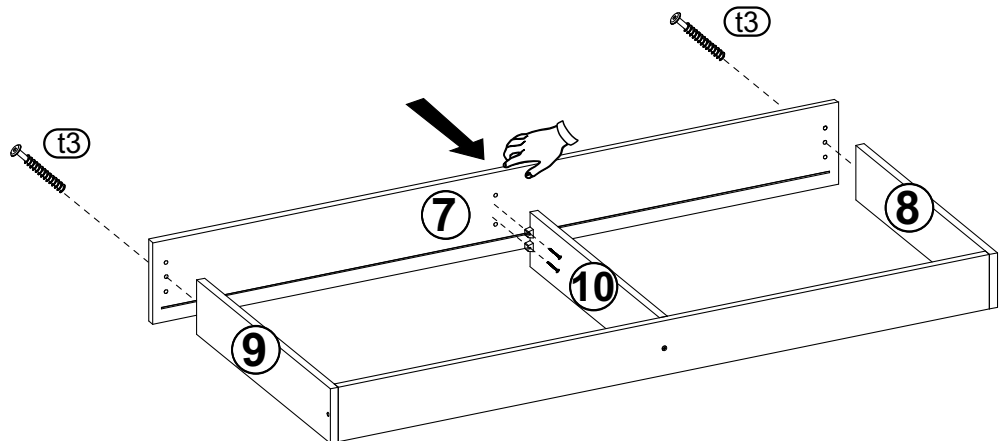
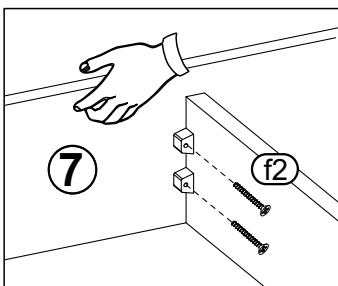
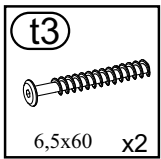
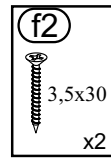
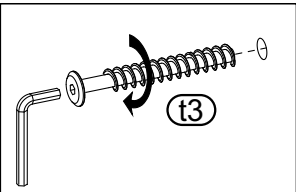



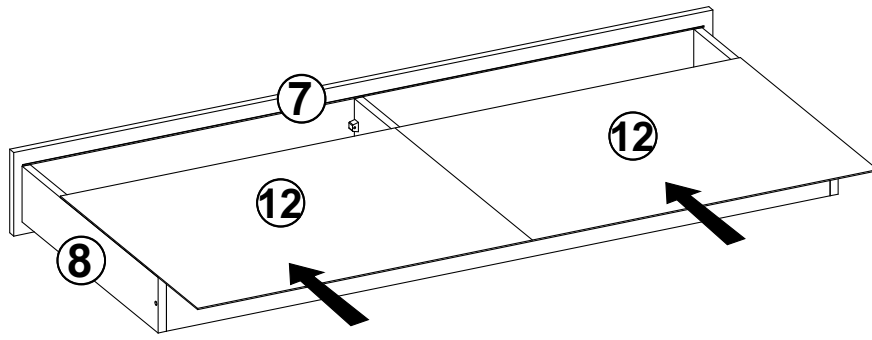

10

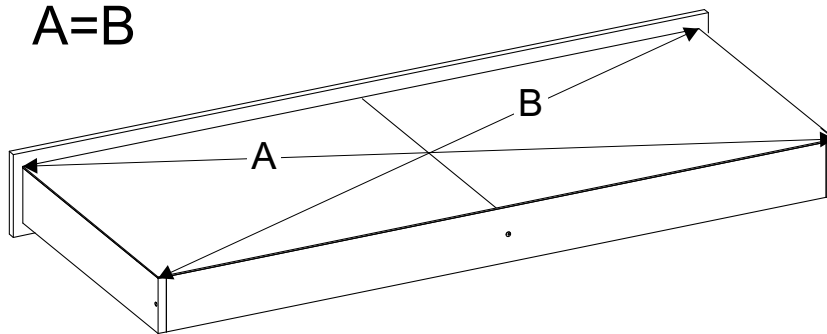
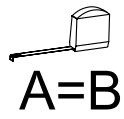

11



12

(h)  2,5x25 x25	(r)  25x12 x5	(f1)  4x16 x8	(w)  4x16 x4
--	--	--	---

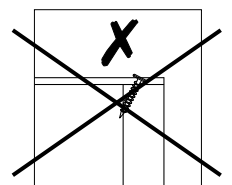
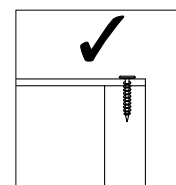
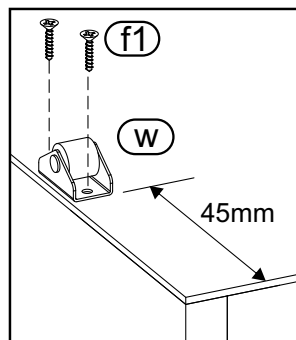
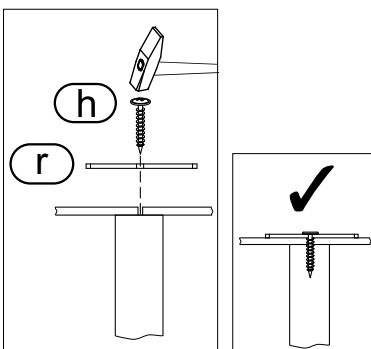
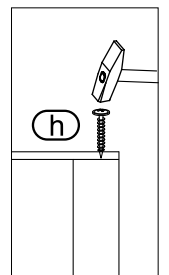
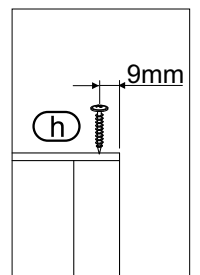
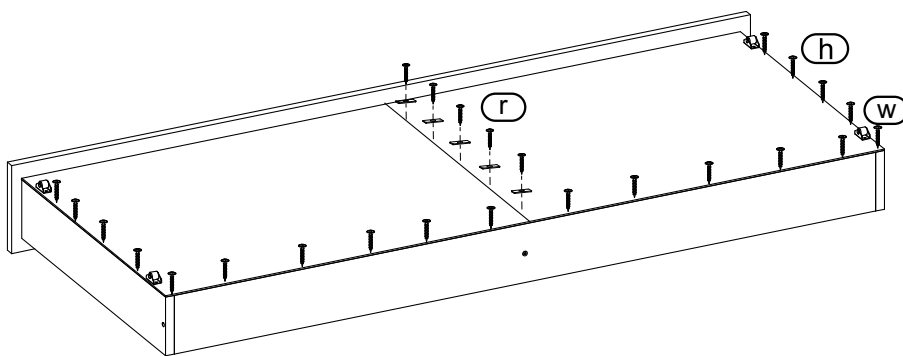

13

